

A:Location planning of anchor-plate2:1

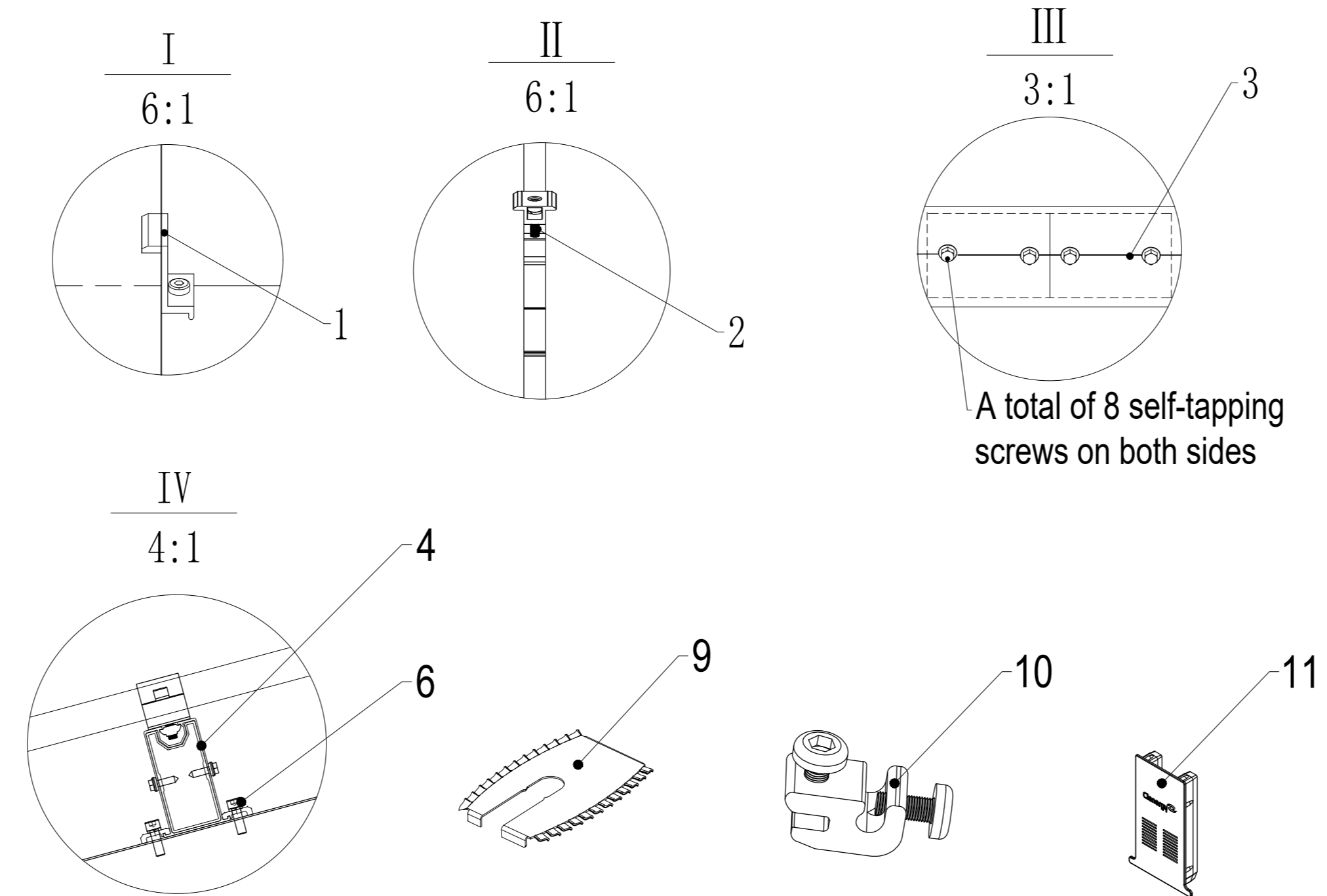
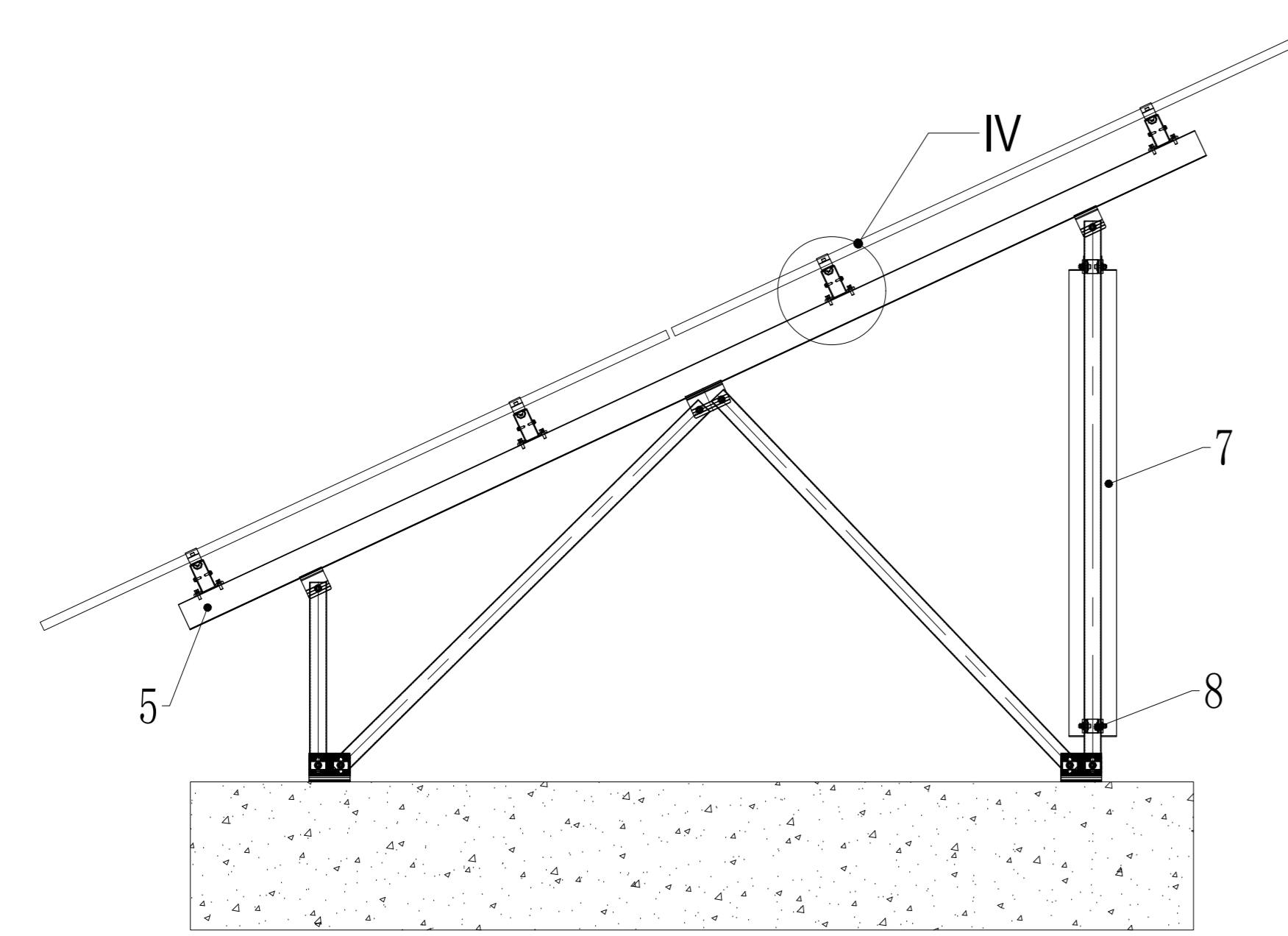

- NOTES:**
- 1.Install angle:25°
 2. Snow load: 0.7KN/m²
 3. Wind load: 34m/s
 4. Panel Type:1903x1134x30
 5. Module per unit:2x8=16
 6. Qty of units:150
 7. Span:2600mm
 - 8.misplacement deviation: ±16mm
 - 9.This design does not contain embedded fasteners

11	CAP-TW100	Cap for TW Rail 100				8		
10	EZ-GL-U	PV-ezRack Universal Grounding Lug				4		
9	EZ-GCII-ST	ez PV-Grounding Clip II				16		
8	CO-RT-55/50	PV-ezRack Connector for Rectangular Tube 55*50				8		
7	ER-AA-50/2980/8	Angle AL-50.8*50.8*2980with bolt hole Ø8.5				4		
6	ER-RCII/W	PV-ezRack Rail Clamp II with W module				32		
5	S-Eco/W/25/92/3	PV-ezRack SolarTerrace Eco,Support(Pre-assembled,W shape) 25 degree, with 92*3700mm Girder				4		
4-2	R-TW100/1000	PV-ezRack TW Rail 100*1000				4		
4-1	R-TW100/4200	PV-ezRack TW Rail 100*4200				8		
3	SP-TW100	PV-ezRack Splice for TW Rail 100				8		
2-2	ER-ICII-W30/32	PV-ezRack Module Inter Clamp II, for Frame Height 30-32mm with W module				28		
1-2	ER-EC-W30	PV-ezRack End Clamp, Standard 30mm with W module				8		
Item	BarCode/Part No.	Drawing NO.	Part Name	Spec.	Material	Qty	Weight:kg	Remark

				Do Not Scale Drawings, Use Figured Dimensions Only		Version	V 1.0	A3
				清源科技股份有限公司 Cleenergy technology co., Ltd.				
Item	Mark	Design Change No.	Design Change Contents	Sign	Date	Title	STECO 16 panels kit	BarCode
		Appv'D	Chk'D	STD	Profread	Design	Material	Weight
Sign							Dwg No.	DFG23EU51339-02DW02
Date							Scale	Qty
						Total pages: P	View	